

WingIts

THE SOLUTIONS COMPANY

COMMERCIAL GRAB BAR FASTENING SYSTEM - INSTALLATION GUIDE

WINGITS' GRAB BAR FASTENING SYSTEMS EXCEED BUILDING CODES FOR GRAB BARS IN THE FOLLOWING WALL SUBSTRATES:

* 5/8" drywall—painted or wallpapered
* 1/2" or 5/8" drywall with tub surrounds
* 1/2" or 5/8" drywall with tile, marble and all stone
* 1/2" or 5/8" drywall with any panel types including fiberglass, faux marble, acrylic and plastics
* Multiple layers of drywall
* Plaster and lathe
* 1/4" acrylic/fiberglass tub surrounds
* Most wall panels
* All masonry type boards, with or without decorative panels

NEVER INSTALL ANY FASTENER INTO WET OR DETERIORATING WALLS!

STRUCTURAL BLOCKING MUST BE USED IN PLAIN 1/2" DRYWALL when attempting to meet commercial building codes.

MAKE SURE YOU HAVE THE RIGHT SIZE WingIt

- > **GBW40** Standard WingIt is used in walls framed with 2 X 4's (3 1/2" hollow or larger).
- > **SRGBW40** Reverse WingIt is used in walls framed with 2 X 3's (2 1/2" hollow or larger).
- > WingIts come standard with a Stainless steel 4" machine screw for walls up to 1 1/4" thick. Longer Screws Available for thicker walls.

CALL FOR CUSTOM PRODUCTS 877.894.6448

FOR MAXIMUM SAFETY AND TO MEET ADA REQUIREMENTS, GRAB BARS SHOULD BE INSTALLED HORIZONTALLY 33-36 INCHES FROM THE FLOOR

LOCATION: To ensure adequate clearance, a stud finder should be used to verify there are no studs within the area where the WingIt will be installed. Once inserted, each wing assembly will spring open almost 3" in diameter.

Tools Required:

- * Screwdriver
- * 1.25" Drill (Our **APACHE 200** rated @ 200 holes in ceramic wall tile)

Before you install:

Verify the length of the grab bar by measuring from the inside of one flange to the outside of the other.

(Continued...)

Make sure that there is at least 1.5" away from the edge of the stud. *If concerned*, drill a pilot hole and insert a piece of wire in the shape of an "L" - twirl the wire to make sure that there is nothing in the way.

Drill a 1 1/4" hole in the wall precisely at the center point where each grab bar flange will align.

Clean wall surface.

Installing with "Grab Bars from WingIts"

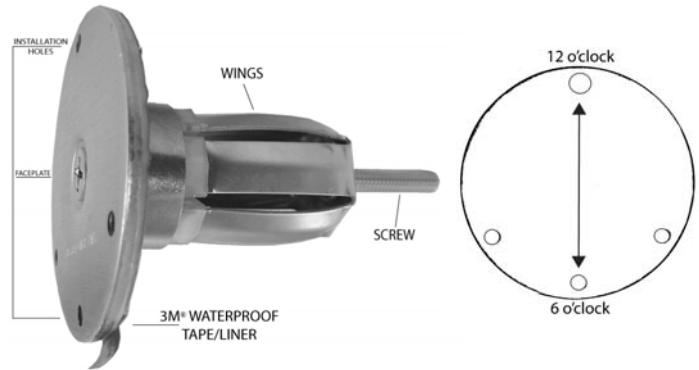

WingIts' Grab Bar Flanges have 3 holes and TWO SLOTS in each flange. Use the TWO SLOTS to attach the grab bar to FACEPLATE.

1. Remove the liner from the 3M® WATERPROOF ADHESIVE on the WingIts
2. Back-out the center screw about the same distance as the wall thickness.
3. Insert the Grab Bar WingIts into the wall with the holes aligned vertically (12 & 6 o'clock).
4. Hold down firmly, allowing the adhesive to stick.
5. Push the screw head to the faceplate to "pop" the WINGS behind the wall (optionally, hit the screw head with a mallet to eject the WINGS).
6. Pull on the screw head and tighten the screw.
7. Attach the Grab Bar with the supplied 10-32X3/16" s/s screws.

WingIts' 18/8 Stainless Steel Grab Bar



MOUNT WITH 2 SCREWS TOP & BOTTOM

With NON-WingIts' Grab Bars-

Confirm the Bar's compatibility with WingIts – 877.894.4466

The WingIts must be assembled to the Grab Bar PRIOR to inserting into the wall as the installation must be more precise. The FACEPLATE hole alignment to the grab bar flange hole MUST be exact.

- * Temporarily attach the WingIts to the Grab Bar
- * Remove the liner from the 3M® WATERPROOF ADHESIVE on the WingIts
- * Insert the WingIts using the Grab Bar as a template
- * Push on Grab Bar for 1/2 a minute to adhere WingIts to the wall
- * Remove Grab Bar
- * Activate and tighten the WingIts as stated in Steps 2—9 above.

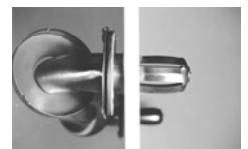

Additional products from WingIts!

World's Strongest Towel Rack

- 50% more structure.
- Stainless Steel.
- Ultimate engineering.
- Quick Installation with the MASTER Anchor—World's Strongest Fastener
- NO BLOCKING REQUIRED!

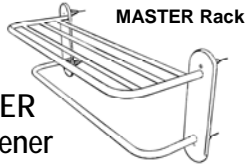

Includes 4 patented MASTER Anchors. (World's Strongest Fasteners) NEVER Rust, NEVER Sag, NEVER Loosen!

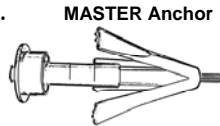

World's Strongest Basket

NO BLOCKING REQUIRED— structural basket for soap or foot rest! Includes the patented MASTER Anchors.

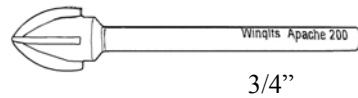

3/4"

WingIts APACHE 200 Drill bits.

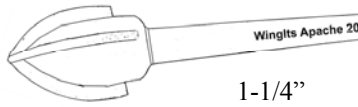

1-1/4"

Fast easy installation — rated at over 200 holes in ceramic wall tile.

WingIts' Commercial Grab Bar WingIt

EASY AS:

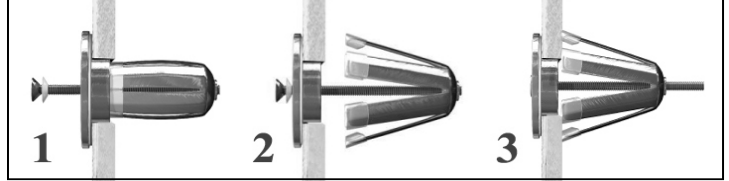

World's Largest Selection of Grab Bars

- 18/8 Stainless Steel
- Concealed Flanges
- ADA Compliant
- Available in different colors and finishes

Decorator Series
Sure Grip

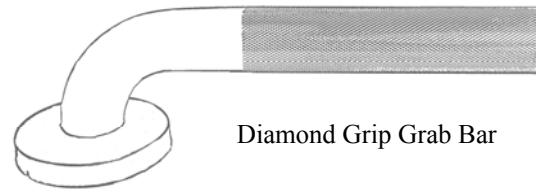

Diamond Grip Grab Bar

OVAL CRESCENT SUITE



Structure, Beauty and Durability throughout the entire Suite!

The ORIGINAL Crescent *curved* Shower Rod

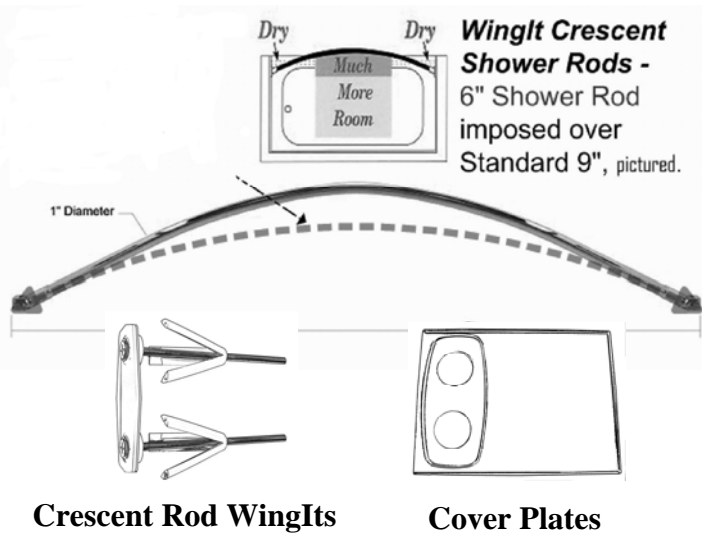

Crescent Rod WingIts

Cover Plates

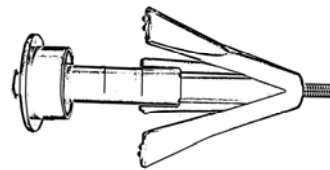

MAW35
MASTER Anchor



RESGBW35
Refined Engineered Safety
Grab Bar WingIt

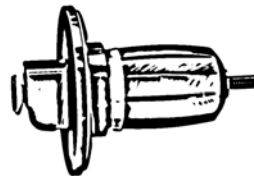

XGBW40
Suspension System WingIt

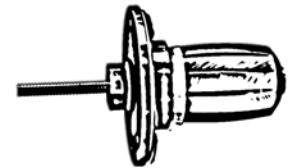

SRGBW40
Special Reverse Grab Bar WingIt

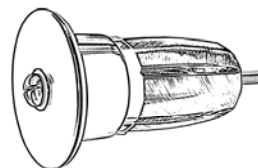

GCW40
Generic Commercial WingIt

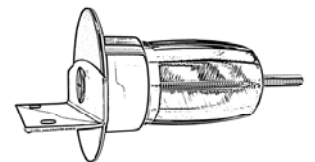

CTW40
Counter Top WingIt