

WINGITS® MODERN Elegance™

Double Toilet Paper Holder

Model:
WMEDTPH

Part Numbers:
WMEDTPHS Polished Finish
WMEDTPHSN Satin Finish



Contemporary design combines with **PATENTED** BridgeBind™ Technology resulting in bathroom accessories with:

- Unparalleled strength
- Beauty
- Functionality
- Durability
- No lines for dirt to collect (maintenance free)

| |
|--|
| MECHANICAL DATA |
| <p>Height: 2" (5.1cm) Length: 14" (35.5cm) Projection: 3.625" (9.2cm)</p> |
| PRODUCT COMPOSITION |
| <p>Entire product is 18/8 (304) solid stainless steel.</p> |
| MODALITY |
| <p>Use: Wall Installation.</p> |
| INSTALLATION |
| <p>WingIts® MODERN Elegance™ Single Toilet Paper Holders are designed to be installed into adequate structural blocking.</p> |
| RECOMMENDED INTEGRATION |
| <p>For the strongest possible installation, it is recommended that WingIts® Master Anchor (MAW35) is used with this product.</p> |

WINGITS®

FRONT

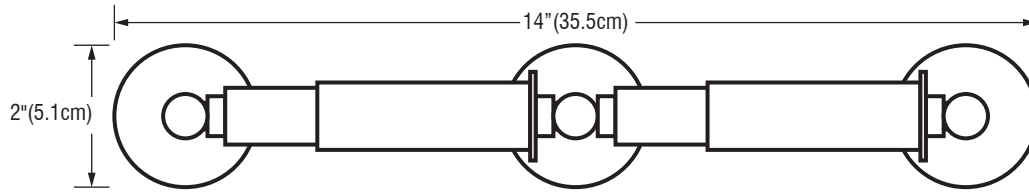

BACK

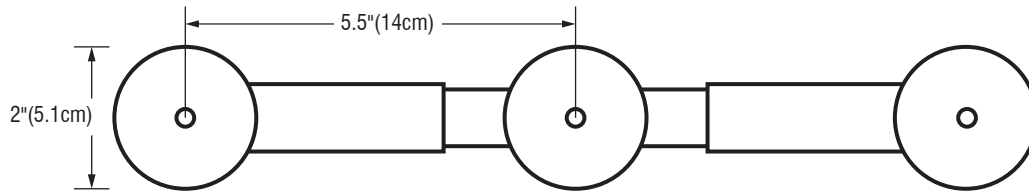

TOP

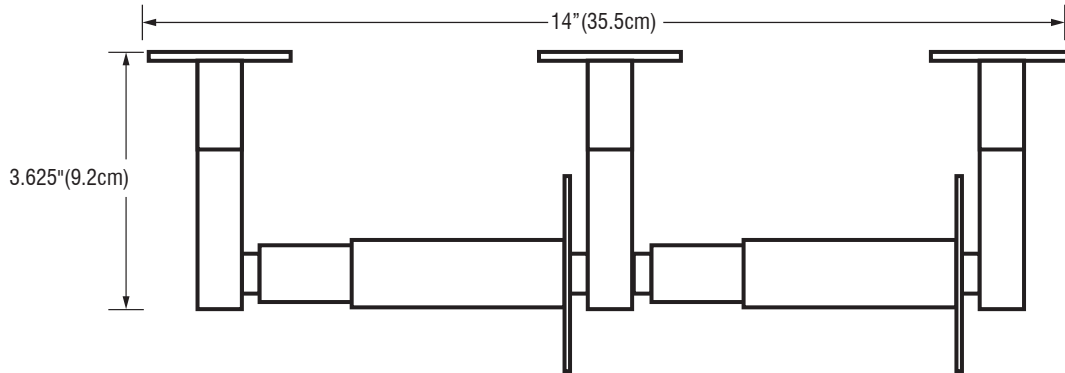

SIDE

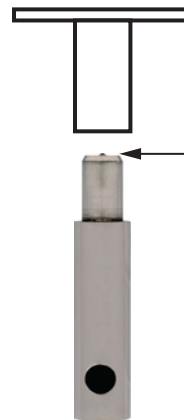
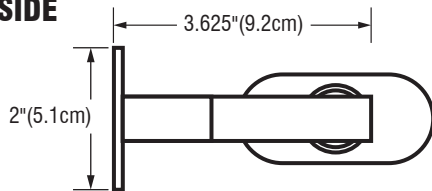

Use the Toilet Paper Holder as its own template.
Put pin to wall to mark drilling location.

INCLUDED HARDWARE

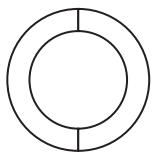

3M® Waterproof ME Tape x 2



S/S Screw for Blocking x 2



Allen Wrench x 1



Set Screw x 2

OPTIONAL HARDWARE

(Sold Separately)

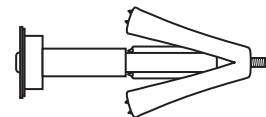

Wingits® Master Anchor
(MAW35) x 2