

WINGITS®

Room Divider

Model:
WRD

Structural Stainless Steel Rod &
Ceiling Mounts

Part Numbers:

WRD5SS86SN
86" Satin Finish



Super Duty Structural Rod Features -

- 18-8 Structural Stainless Steel Construction
- Rectangular Heavy Duty Rod Designed to Maximize Structure while Allowing Easy Curtain Movement
- Engineered to be Structural and withstand 100lb Loads
- Engineered to "break-away" prior to destroying the ceiling - replacement pins at no cost from WINGITS®
- No Maintenance Design



MECHANICAL DATA
Length: 86" (2184mm) Flange Cover Diameter: 3" (76mm) Load Capacity/Breakaway designed at 100lb (45kg)
COMPOSITION
18-8 (304) Stainless Steel
INSTALLATION
WINGITS® Structural Stainless Steel Room Dividers must be installed into Adequate Ceiling Structures.

Side

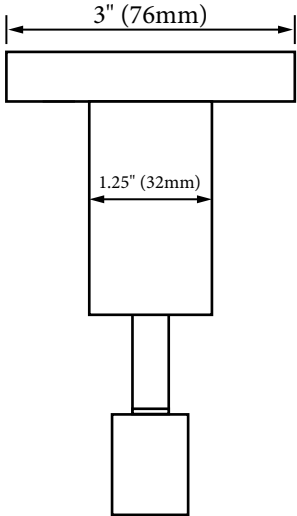

Front

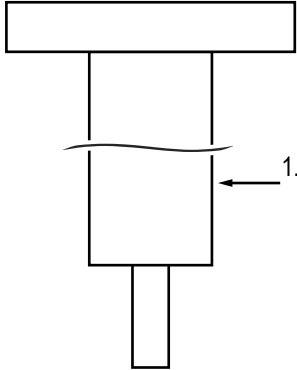
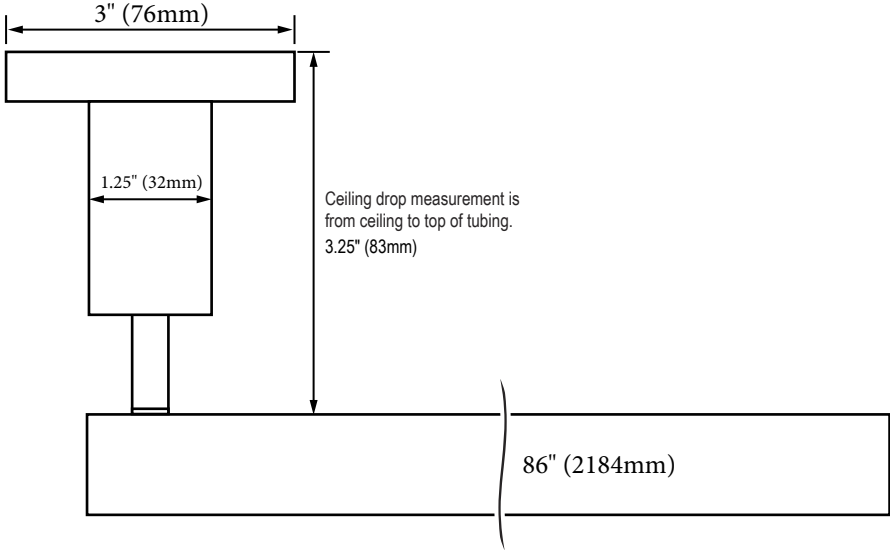

Custom Sizing Available
1.25" tube can be extended
for taller ceilings

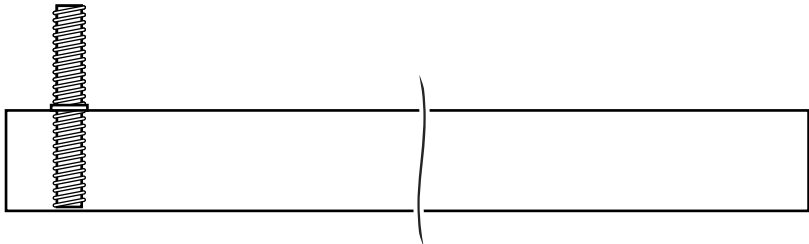
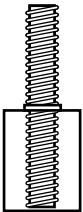
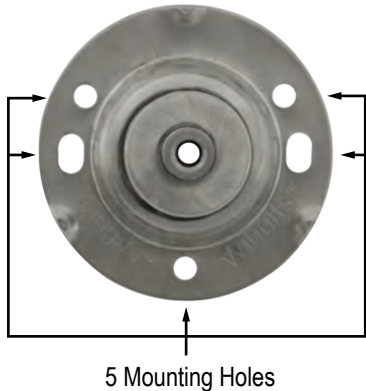
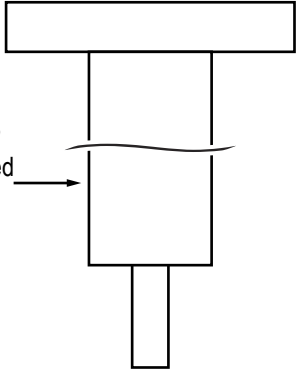

Included Hardware



Allen Wrench (1)



Set Screw (2)