

WINGITS® MAX Elegance™

Stainless Steel Single Button Robe Hook

Model:
WXESBRH

Part Numbers:
WXESBRHPS Polished Finish
WXESBRHSN Satin Finish

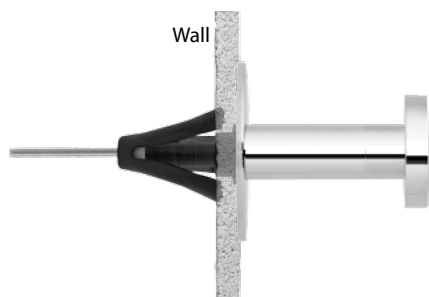

- Made of 18/8 (304) stainless steel
- Patented BridgeBind™ Technology - fully HeliArc welded construction
- Rated up to 100 lbs
- Available in high polished or satin finishes - compliments any bathroom style
- Functionality - durability - maintenance free
- Easy installation - guaranteed to NEVER loosen using WingIts® Fasteners (optional)
- Clean flowing lines through minimalist design
- Coordinates with other products in the MAX Elegance™ collection

PATENTED
BridgeBind™ Technology



BridgeBind™ technology is the result of drilling a hole completely through stainless steel rod - inserting a solid stainless steel pin and HeliArc welding the pin to the far point of the tube - solidifying the pin and tube into one piece - CREATING THE ULTIMATE STRUCTURAL BOND.

MECHANICAL DATA
Height: 2" (5.08cm)
Length: 2" (5.08cm)
Projection: 2.625" (6.67cm)
PRODUCT COMPOSITION
Entire product is solid 18/8 (304) HeliArc welded stainless steel.
MODALITY
Use: Wall installation
INSTALLATION
WINGITS® MAX Elegance™ Robe Hooks are designed to be installed into adequate structural blocking or with optional WINGITS® MASTER Anchor™ Fastener (MAW35) for hollow wall construction.

WINGITS®

Front

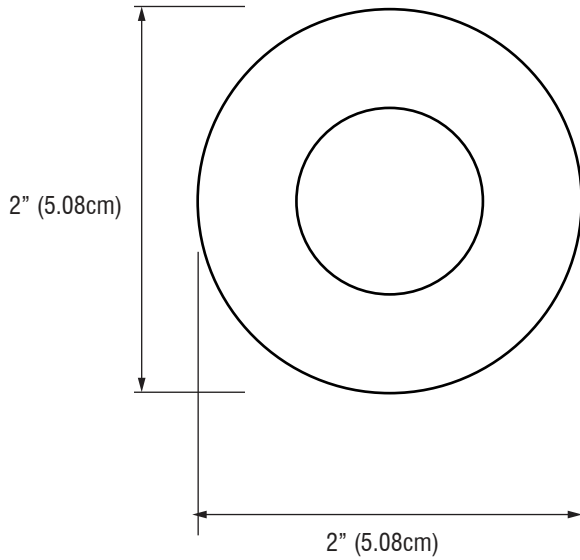

Back

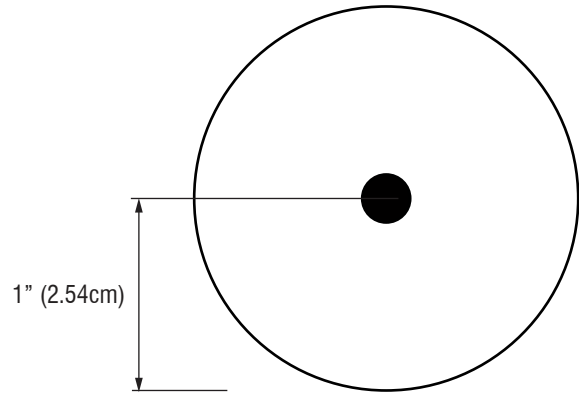

Top

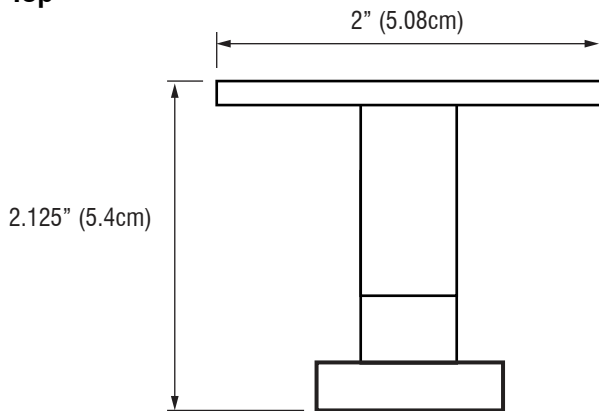

Side

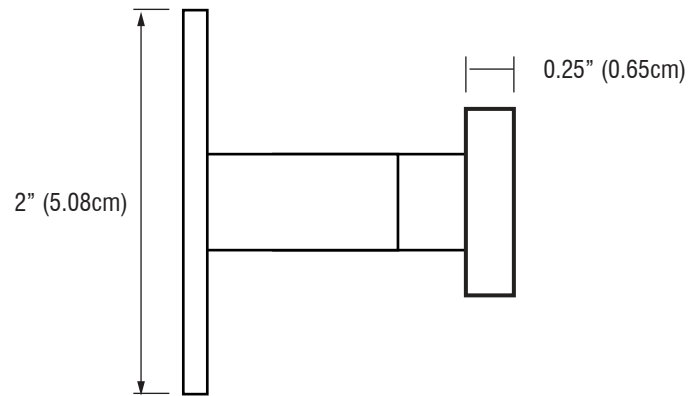

INCLUDED HARDWARE

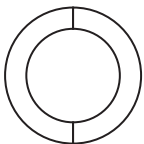

3M® VHB Waterproof Tape x 1



Large Screw x 1

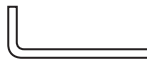

Allen Wrench x 1



Set Screw x 1

OPTIONAL HARDWARE

(Sold Separately)

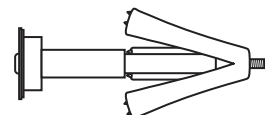

WINGITS® MASTER Anchor™
(MAW35) x 1