

# WINGITS® Accessory Panel

## 18/8 Stainless Steel

**Model:**  
**WRITB2RH**

**Part Numbers:**  
**WRITB2RHPS**  
Polished Finish



Contemporary design combines with **PATENTED** BridgeBind™ Technology resulting in an Accessory Panel with:

- Unparalleled strength
- Beauty
- Functionality
- Durability
- No lines for dirt to collect (maintenance free)

BridgeBind™ Technology is the result of drilling a hole completely through stainless steel tubing, inserting a solid stainless steel pin, and HeliArc welding the pin to the far point of the tube; solidifying the pin and tube into one piece. Creating the ultimate structural bond.

<b>MECHANICAL DATA</b>	
<b>Height:</b> 6" (15.2cm)	<b>Weight:</b> 19 lbs. (8.6kg)
<b>Width:</b> 40" (101.6cm)	
<b>Depth:</b> 3.25" (8.3cm)	
<b>PRODUCT COMPOSITION</b>	
Entire product is 18/8 (304) stainless steel. Solid caps and pins are HeliArc welded to 18 gauge tube or rod.	
<b>MODALITY</b>	
<b>Use:</b> Wall Installation.	
<b>INSTALLATION</b>	
<b>WingIts®</b> Accessory Panels are designed to be <b>installed into adequate structural blocking</b> or with <b>WingIts®</b> Hollow Wall Anchors (included).	
<b>RECOMMENDED INTEGRATION</b>	
For hollow wall installation, it is recommended that the included <b>WingIts®</b> Hollow Wall Anchors are used with this product.	

WRITB2RH\_SpecSheet\_20140321\_rev5



# 18/8 Stainless Steel Accessory Panel is Fully Reversible

**TOP**

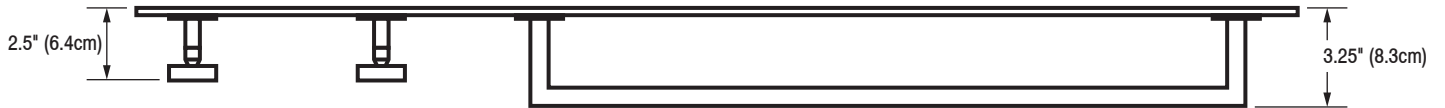

**FRONT**

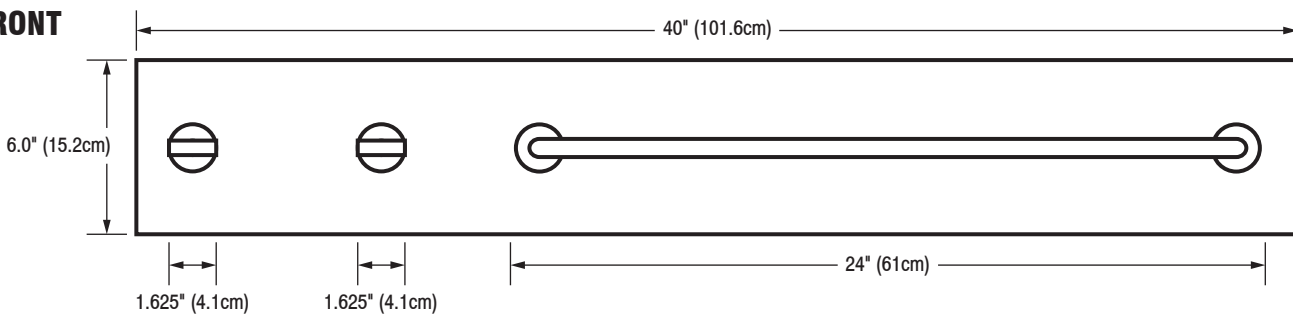

**SIDE**

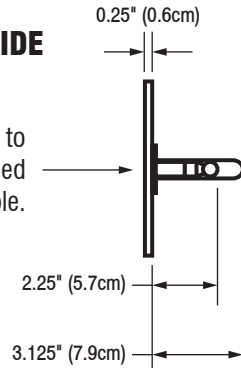

Use stainless steel plate as a template to mark the wall to install the four included **WINGITS**® Hollow Wall Anchors and assemble.

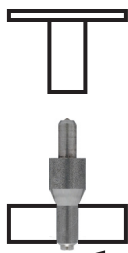

BridgeBind™ Technology: Solid stainless steel pin is HeliArc welded to solid stainless steel rod.

Fully HeliArc welded construction

**INCLUDED HARDWARE**

Comes with 4 FREE **WINGITS**® Fasteners.  
The World's Strongest Fasteners™  
for Hollow Wall Construction

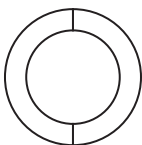

Large 3M® Waterproof ME Tape x 2

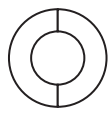

Small 3M® Waterproof ME Tape x 2



Allen Wrench x 1



Set Screw x 4

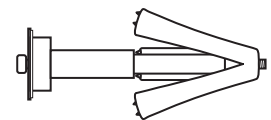

**WINGITS**® Hollow Wall Anchor x 4