

# WINGITS® INFINITE Elegance™

## Mitered Double Robe Hook

**Model:**  
**WIEDRH**

**Part Numbers:**

**WIEDRHPS**

Polished Finish

**WIEDRHSN**

Satin Finish

*Stainless steel screws are included to install into adequate structural blocking.*



Contemporary design combined with **PATENTED** BridgeBind™ Technology resulting in a Robe Hook with:

- Unparalleled strength
- Beauty
- Functionality
- Durability
- No lines for dirt to collect  
(maintenance free)

MECHANICAL DATA	
<b>Height:</b> 1.625" (4.1cm)	<b>Weight:</b> 6 oz. (170g)
<b>Width:</b> 3" (7.6cm)	
<b>Depth:</b> 2.125" (5.4cm)	
PRODUCT COMPOSITION	
Entire product is 18/8 (304) stainless steel. Solid caps and pins are HeliArc welded to 18 gauge tube.	
MODALITY	
<b>Use:</b> Wall Installation.	
INSTALLATION	
<b>WINGITS®</b> Stainless Steel Double Robe Hooks are designed to be <b>installed into adequate structural blocking.</b>	
RECOMMENDED INTEGRATION	
It is recommended that <b>WINGITS®</b> Master Anchor (MAWME35) is used with this product.	

# WINGITS®

**FRONT**

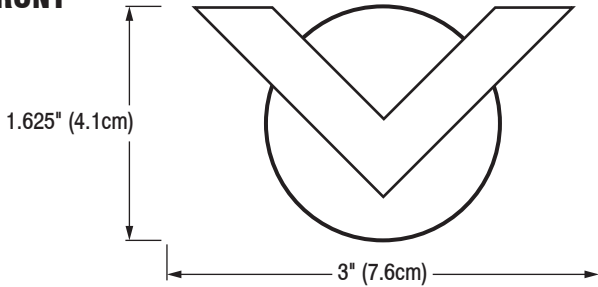

**BACK**

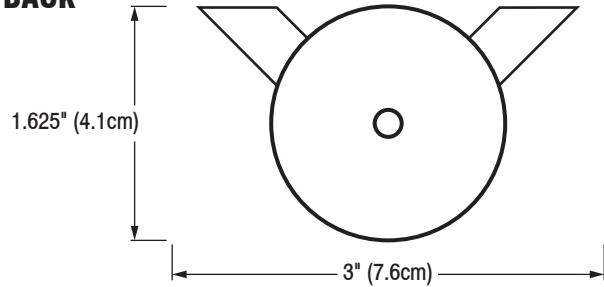

**SIDE**

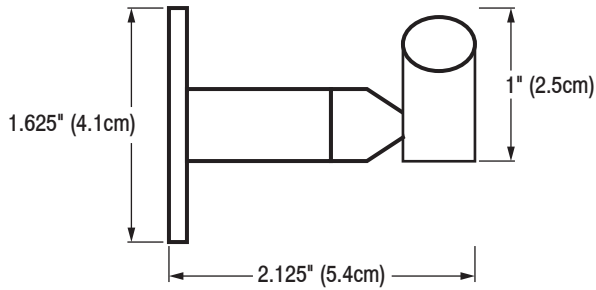

**TOP**

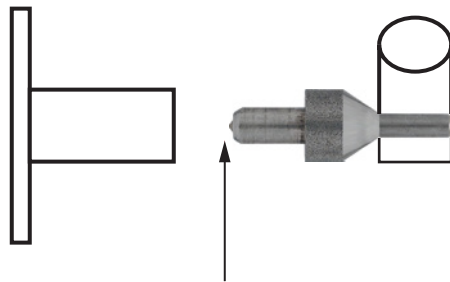
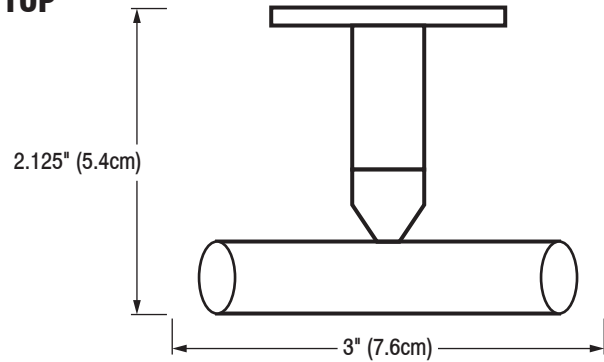

BridgeBind™ Technology:  
Solid stainless steel pin is HeliArc  
welded to stainless steel tube.

Use the Robe Hook as its own template.  
Put pin to wall to mark drilling location.

**INCLUDED HARDWARE**

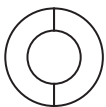

3M® Waterproof ME Tape x 1



Allen Wrench x 1



S/S Screw for Blocking x 1



Set Screw x 1

**OPTIONAL HARDWARE**

(Sold Separately)

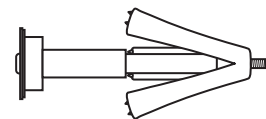

WingIts® Master Anchor for MODERN Elegance™  
Bath Accessories (MAWME35) x 1