

WINGITS® INFINITE Transitional™

Double Mitered Robe Hook

Model:
WITDRH

Part Numbers:

WITDRHPS
Polished Finish

WITDRHSN
Satin Finish



Contemporary design combines with **PATENTED** BridgeBind™ Technology resulting in a Robe Hook with:

- Structural Stainless Steel
- Beauty-Functionality-Durability
- No lines for dirt to collect - maintenance free
- Unparalleled strength

BridgeBind™ Technology is the result of drilling a hole completely through stainless steel tubing, inserting a solid stainless steel pin, and HeliArc welding the pin to the far point of the tube; solidifying the pin and tube into one piece. Creating the ultimate structural bond.

MECHANICAL DATA
Height: 1.625" (4.1cm) Length: 2.25" (5.7cm) Projection: 2.125" (5.4cm)
PRODUCT COMPOSITION
Entire product is 18/8 (304) stainless steel. Solid caps and pins are HeliArc welded to 18 gauge tube.
MODALITY
Use: Wall Installation.
INSTALLATION
WingIts® INFINITE Transitional™ Stainless Steel Double Robe Hooks are designed to be installed into adequate structural blocking or with optional WingIts® Fastener.
RECOMMENDED INTEGRATION
It is recommended that WingIts® Master Anchor (MAWME35) is used with this product.

WINGITS®

FRONT

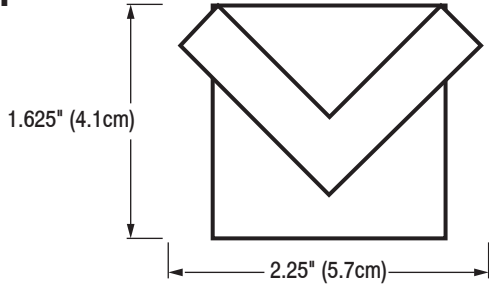

BACK

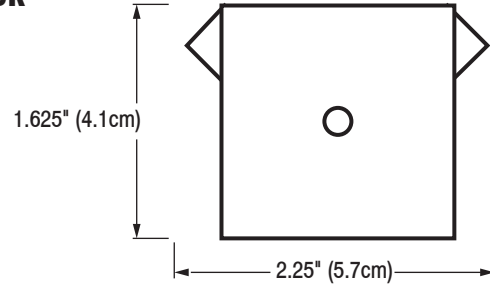

SIDE

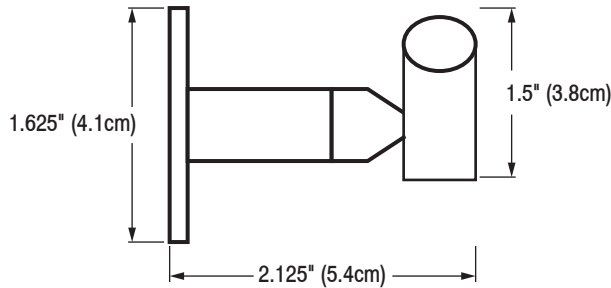

TOP

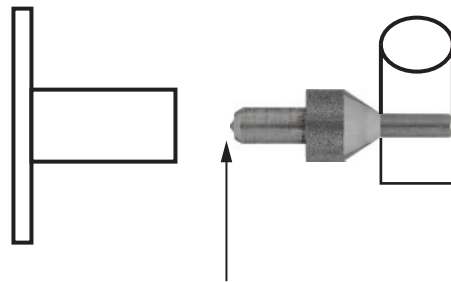
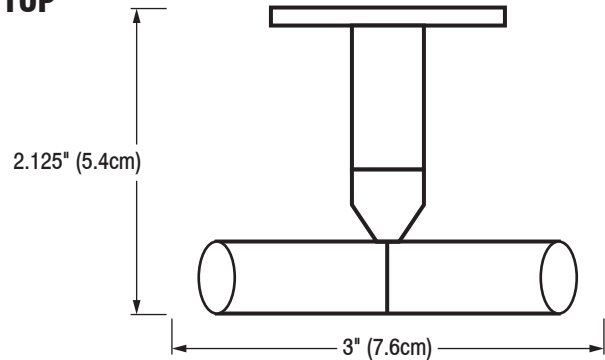

BridgeBind™ Technology:
Solid stainless steel pin is HeliArc
welded to stainless steel tube.

Use the Robe Hook as its own template.
Put pin to wall to mark drilling location.

INCLUDED HARDWARE

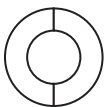

3M® Waterproof ME Tape x 1



Allen Wrench x 1



S/S Screw for Blocking x 1



Set Screw x 1

OPTIONAL HARDWARE

(Sold Separately)

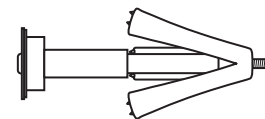

WingItz® Master Anchor (MAWME35) x 1