

WINGITS®

MODERN Transitional™

Stainless Steel 24" Slide Bar Assembly Grab Bar and Hand Shower Holder Combo

Model:

WMT

Part Numbers:

WMTSBA24PS
Polished Finish

WMTSBA24SN
Satin Finish

COMBO UNIT CONSISTS OF THE FOLLOWING:

- (1) 24" Grab Bar
- (1) Hand Shower Holder



Contemporary design and PATENTED BridgeBind™ Technology results in a Grab Bar with:

- Unparalleled strength
- Sleek modern appearance
- No lines for dirt to collect - maintenance free
- Grab Bar and removable Hand Shower Holder are ADA Compliant

BridgeBind™ Technology is the result of drilling a hole completely through stainless steel tubing, inserting a solid stainless steel pin and HeliArc welding the pin to the far point of the tube; solidifying the pin and tube into one piece. Creating the ultimate structural bond.

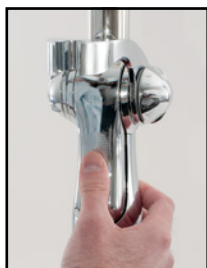
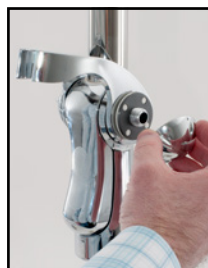

MECHANICAL DATA
Length: 1 Grab Bar at 24" (61cm) Diameter: 1.25" (3.2cm)
PRODUCT COMPOSITION
Grab Bar is 18/8 (304) Stainless Steel, Hand Shower Holder is Acrylonitrile butadiene styrene (thermoplastic).
MODALITY
Use: Wall installation. Load Capability: 800 lbs (362.9kg).
INSTALLATION
WINGITS® MODERN Transitional™ Stainless Steel Grab Bars are designed to hold live loads and must be installed into adequate structural blocking or with WINGITS® Grab Bar Fasteners (GBWME40).
CERTIFICATIONS
WINGITS® MODERN Transitional™ Structural Stainless Steel Grab Bars meet or exceed applicable requirements of all building codes, ADA Criteria, and 2010 ACAAGard 2009 ANSI standards.
RECOMMENDED INTEGRATION
For Hollow wall construction, it is recommended that WINGITS® Grab Bar Fasteners (GBWME40) are used with this product. See Fastener instructions for application.

WINGITS®

(1) Hand Shower Holder

Top

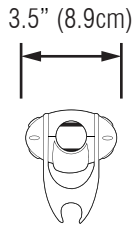

Front

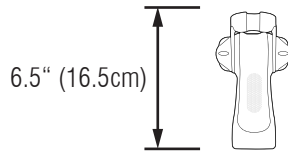

Side

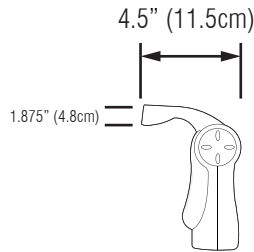

Back

Diameter for tubing is 1.25" (3.2cm)

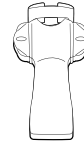

(1) 24" Grab Bar

Top

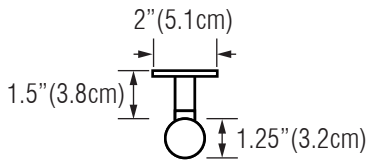

Front

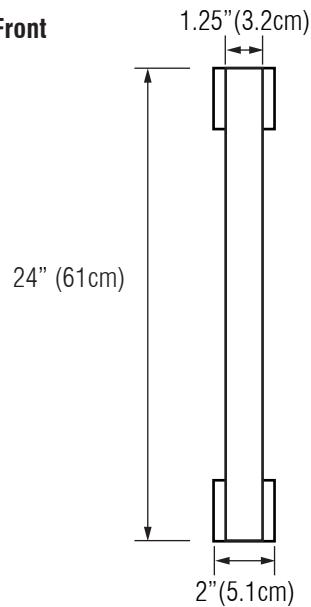

Side

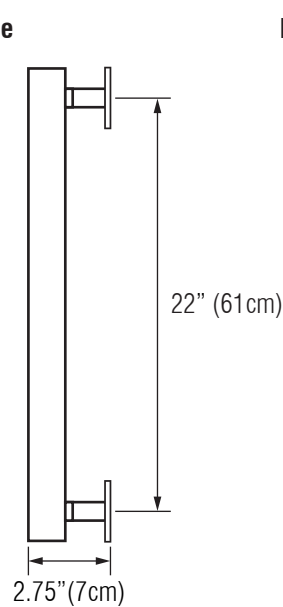

Back

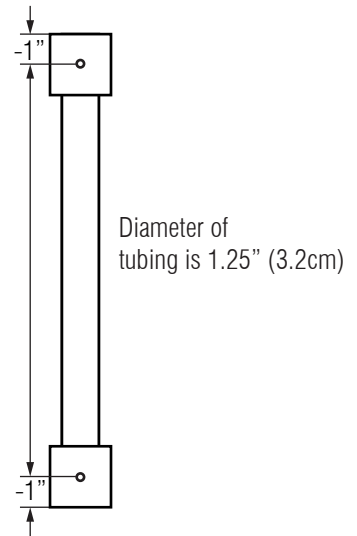

BridgeBind™ Technology: Solid stainless steel pin is HeliArc welded to stainless steel tube.

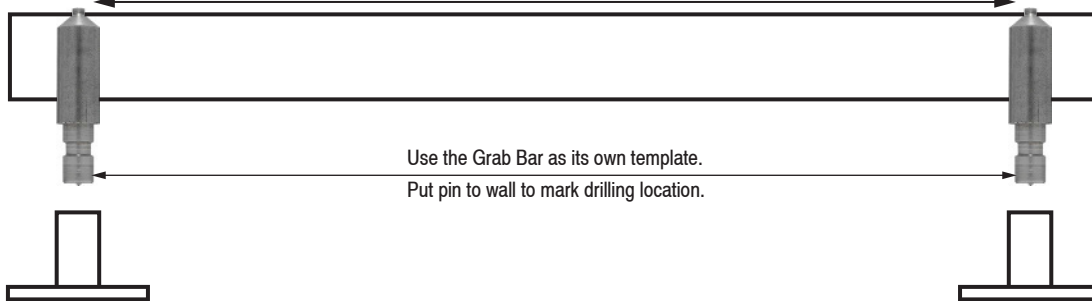

INCLUDED HARDWARE

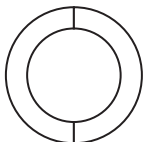

3M® VHB Waterproof Tape x 2



Large Screw x 2

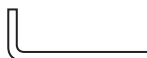

Allen Wrench x 1



Set Screw x 2

OPTIONAL HARDWARE

(Sold Separately)

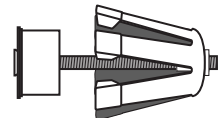

WingIts® MODERN Transitional™
Grab Bar Fasteners (GBWME40) x 2