

WINGITS® MODERN Transitional™

Stainless Steel Single Robe Hook

Model:
WMTSRH

Part Numbers:
WMTSRHPS Polished Finish
WMTSRHSN Satin Finish



Contemporary design combines with **PATENTED** BridgeBind™ Technology resulting in a Robe Hook Holder with:

- Unparalleled strength
- Beauty-Functionality-Durability
- No lines for dirt to collect (maintenance free)

BridgeBind™ Technology is the result of drilling a hole completely through stainless steel tubing, inserting a solid stainless steel pin, and HeliArc Welding the pin to the far point of the tube; solidifying the pin and tube into one piece. Creating the ultimate structural bond.

MECHANICAL DATA
<p>Height: 1.625" (4.1cm) Length: 1.625" (4.1cm) Projection: 2.25" (5.7cm)</p>
PRODUCT COMPOSITION
Entire product is solid 18/8 (304) HeliArc welded stainless steel.
MODALITY
Use: Can be used in any position.
INSTALLATION
<p>WINGITS® MODERN Transitional™ Robe Hooks are designed to be installed into adequate structural blocking or with WINGITS® MASTER Anchor™ Fastener for MODERN Transitional™ Bath Accessories (MAWME35).</p>
RECOMMENDED INTEGRATION
It is recommended that WINGITS® MASTER Anchor™ for MODERN Transitional™ Bath Accessories (MAWME35) is used with this product.

WMTSRH(PS)(SN)_SpecSheet_20141104

WINGITS®

FRONT

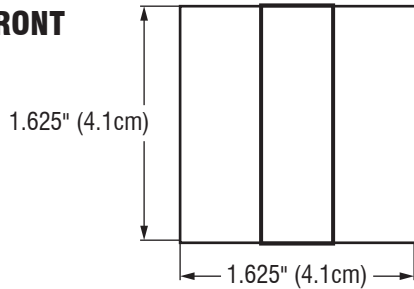

BACK

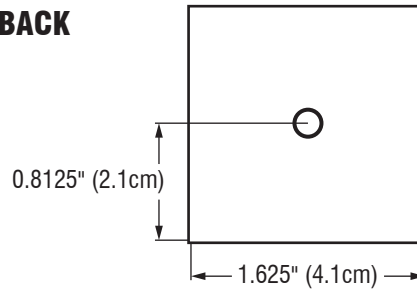

TOP

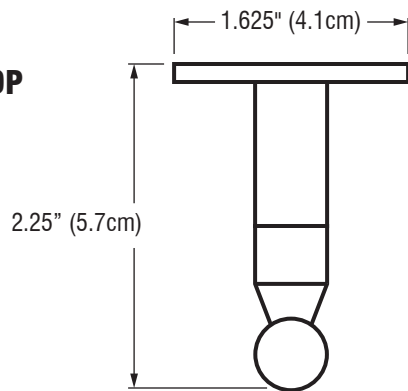

SIDE

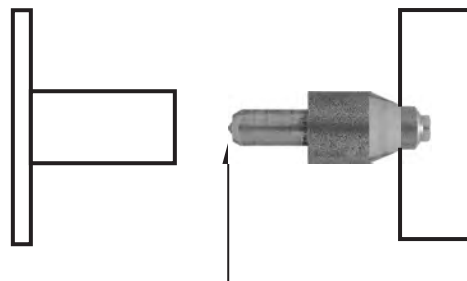
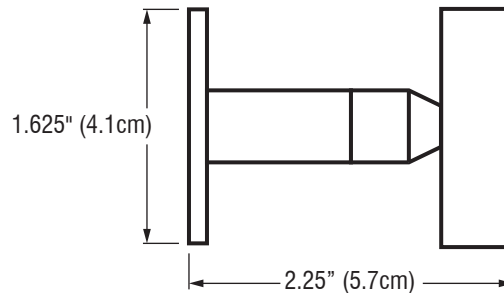

BridgeBind™ Technology:
Solid stainless steel pin is HeliArc
welded thru solid stainless steel rod.

Use the Robe Hook as its own template.
Put pin to wall to mark drilling location.

INCLUDED HARDWARE

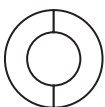

3M® Waterproof ME Tape x 1



Allen Wrench x 1



S/S Screw for Blocking x 1



Set Screw x 1

OPTIONAL HARDWARE

(Sold Separately)

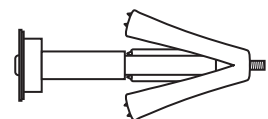

Wingits® MASTER Anchor™ for MODERN Transitional™
Bath Accessories (MAWME35) x 1