

WINGITS®

CANTED Elegance™

Double Toilet Paper Holder

Model:

WCNDEDTPH

Part Numbers:

WCNDEDTPHPS
Polished Finish

WCNDEDTPHSN
Satin Finish

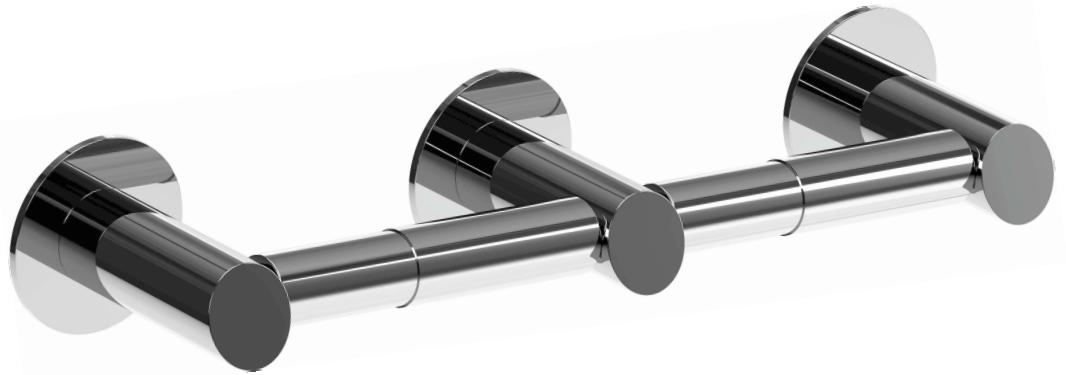

Features:

- Minimal, Elegant Design with CANTED Faces
- ALL 18-8 (304) Stainless Steel Construction
- Can Be Installed with WINGITS® Fasteners (optional)
- Superior Structure with Beautiful Finish



MECHANICAL DATA

Length: 15" (381mm)

Height: 2.5" (64mm)

Depth: 3.375" (86mm)

COMPOSITION

18-8 (304) Stainless Steel

INSTALLATION

Includes Stainless Steel Screws to Install into **Adequate Structural Blocking**.

Includes 3M® VHB Waterproof Tape.

Can Be Installed with WINGITS® Fasteners when blocking is not available.

RECOMMENDED INTEGRATION

PROPER INSTALLATION REQUIRES use of 3M® VHB Waterproof Tape to stop rotation and **MUST** be installed into **Adequate Structural Blocking** or with optional WINGITS® Fasteners.

WINGITS® CANTED™ design is available in all Bath Accessories.

Front

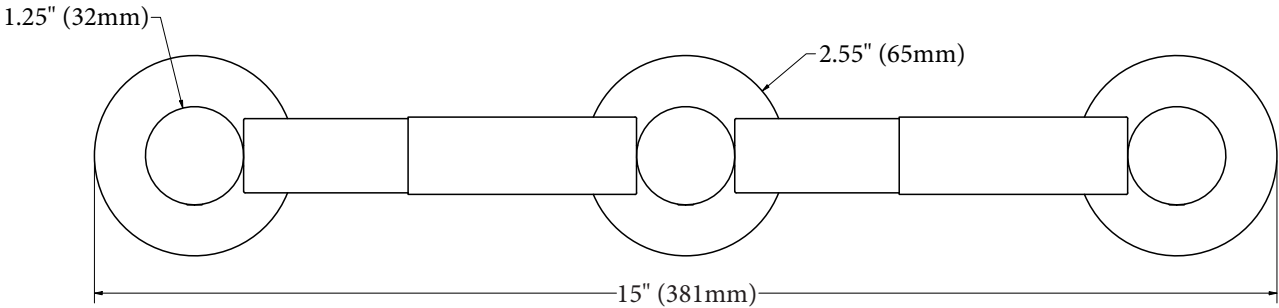



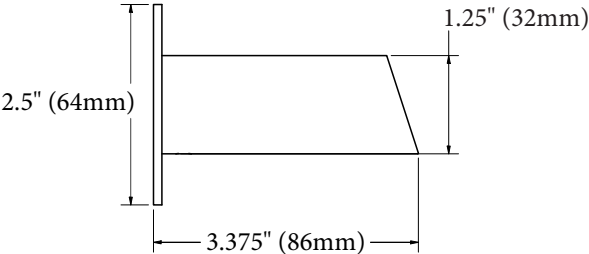

Side

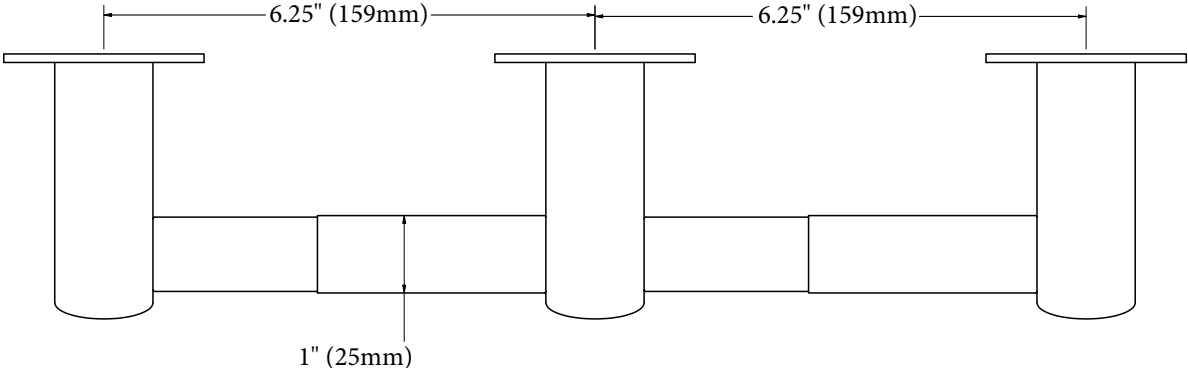

Top

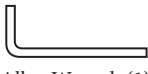

Included Hardware

-  3M[®] Waterproof Tape (3)
-  Steel Screw (3)
-  Allen Wrench (1)
-  Set Screw (3)

**Optional Hardware
(Sold Separately)**

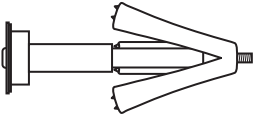
-  WINGITS[®] MASTER Anchor™ (MAW35) (3)