

WINGITS®

LINEAR Transitional™

Horizontal Toilet Paper Holder

Model:

WLTHTPH

Part Numbers:

WLTHTPHS
Polished Finish

WLTHTPHSN
Satin Finish

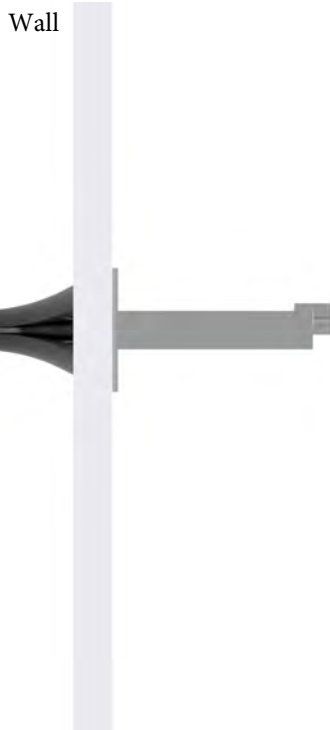
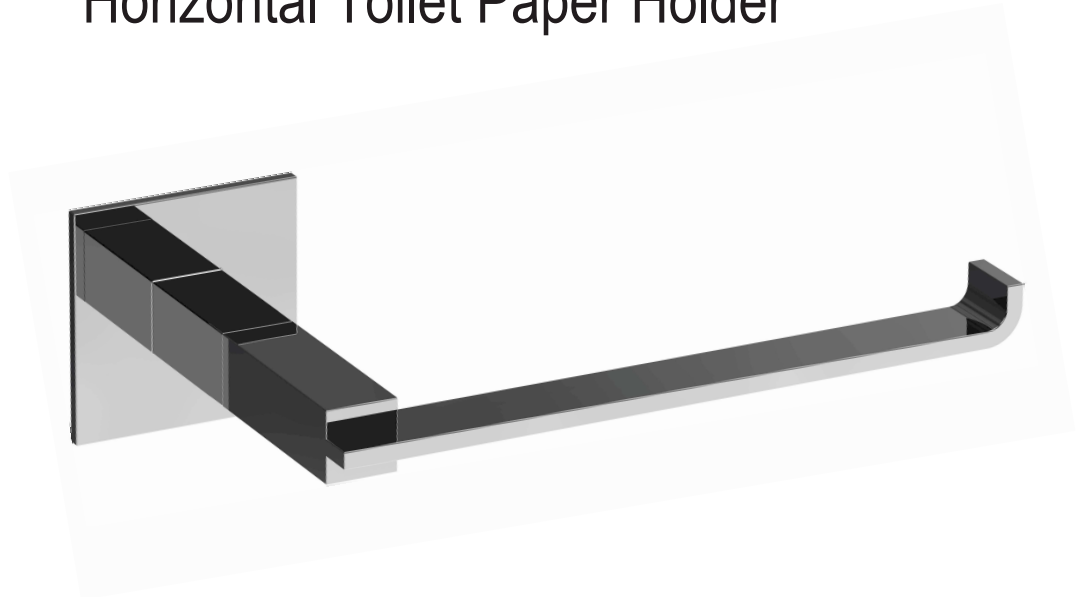

Features:

- Stainless Steel Carved, Welded & Polished
- Structured Horizontal Toilet Paper Holder
- LINEAR Design - Ultimate Durability & Low Maintenance

MECHANICAL DATA
Length: 6.8125" (173mm)
Height: 2" (51mm)
Depth: 3.55" (90mm)
COMPOSITION
18-8 (304) Stainless Steel
INSTALLATION
Includes Stainless Steel Screws to Install into Adequate Structural Blocking . Includes 3M® VHB Waterproof Tape. Can Be Installed with WINGITS® Fasteners when blocking is not available.
RECOMMENDED INTEGRATION
PROPER INSTALLATION REQUIRES use of 3M® VHB Waterproof Tape to stop rotation and MUST be installed into Adequate Structural Blocking or with optional WINGITS® Fasteners. WINGITS® LINEAR™ design is available in all Bath Accessories.

Front

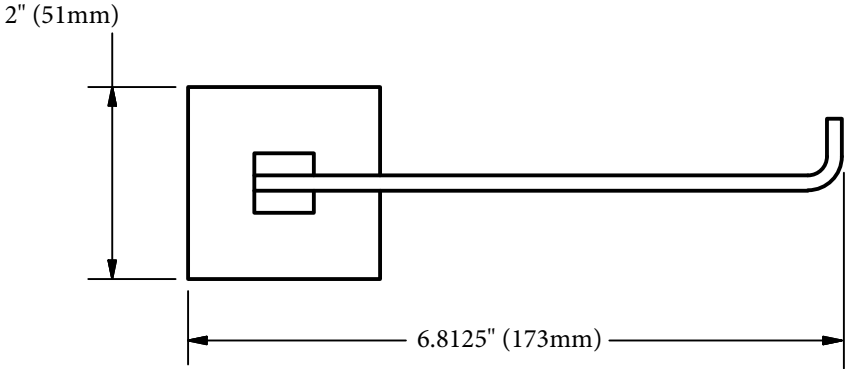

Top

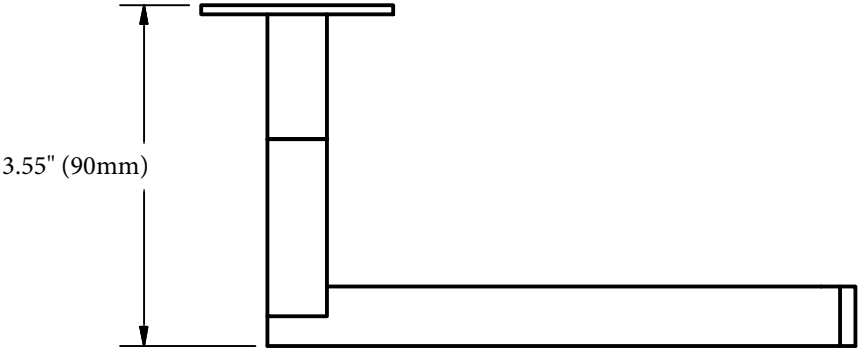



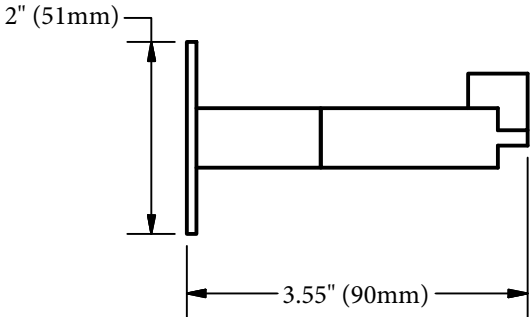

Side

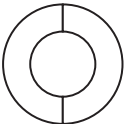

Included Hardware

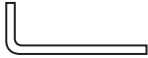
**Optional Hardware
(Sold Separately)**

-  3M[®] Waterproof Tape (1)
-  2.5" S/S Screw (1)
-  Allen Wrench (1)
-  Set Screw (1)

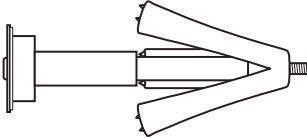
-  WINGITS[®] MASTER Anchor (MAW35)
(1)