

WINGITS®

MODERN Elegance™

Horizontal/Vertical Toilet Paper Holder

Model:

WMEHVTPH

Part Numbers:

WMEHVTPHPS
Polished Finish

WMEHVTPHSN
Satin Finish



Features:

- Modern design combined with **PATENTED BridgeBind™** Manufacturing creates the ultimate in bath accessories
- No Lines for Dirt to Collect - Maintenance Free
- Hand Polished Stainless Steel

MECHANICAL DATA

Length/Height: 6" (152mm)
 Height: 2" (51mm)
 Depth: 3" (76mm)
 Tube Diameter: 0.875" (22mm)

COMPOSITION

18-8 (304) Stainless Steel

INSTALLATION

Includes Stainless Steel Screws to Install into **Adequate Structural Blocking**.
 Includes 3M® VHB Waterproof Tape.
 Can Be Installed with WINGITS® Fasteners when blocking is not available.

RECOMMENDED INTEGRATION

PROPER INSTALLATION REQUIRES use of 3M® VHB Waterproof Tape to stop rotation and **MUST** be installed into **Adequate Structural Blocking** or with optional WINGITS® Fasteners.

WINGITS® MODERN™ design is available in all Bath Accessories.

PATENTED

BridgeBind™ Technology



A steel dowel is expertly embedded in a stainless steel tube then arc welded to the tube's far side for the perfect structural synthesis

Front

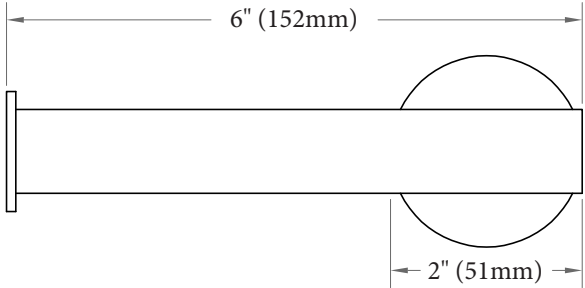

Back

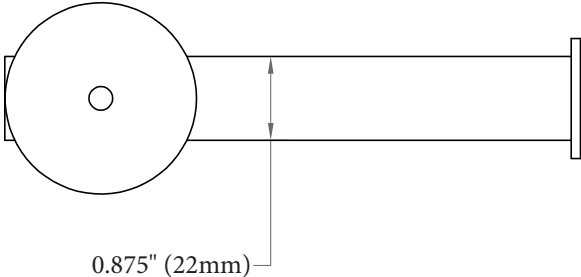

Top

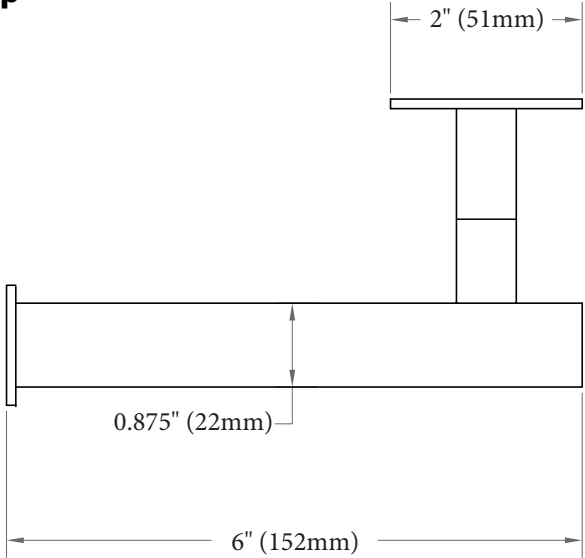

Side

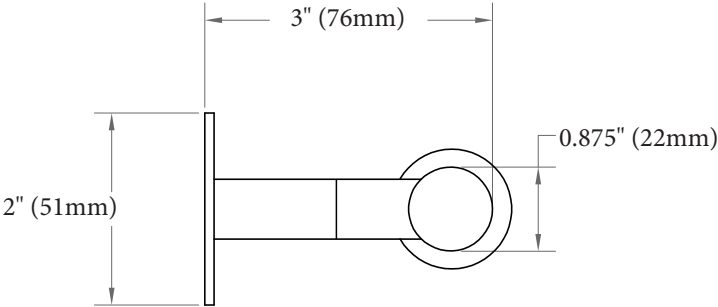

Included Hardware

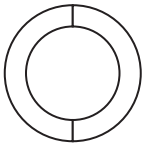

3M[®] Waterproof Tape (1)



2.5" S/S Screw (1)

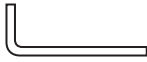

Allen Wrench (1)



Set Screw (1)

**Optional Hardware
(Sold Separately)**

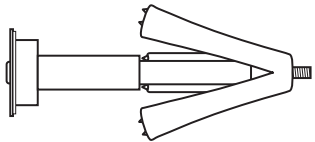

WINGITS[®] MASTER Anchor (MAW35)
(1)