

WINGITS®

MODERN Transitional™

Double Horizontal Toilet Paper Holder

Model:

WMTDHTPH

Part Numbers:

WMTDHTPHPS
Polished Finish

WMTDHTPHSN
Satin Finish

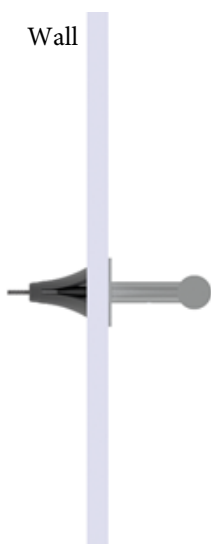
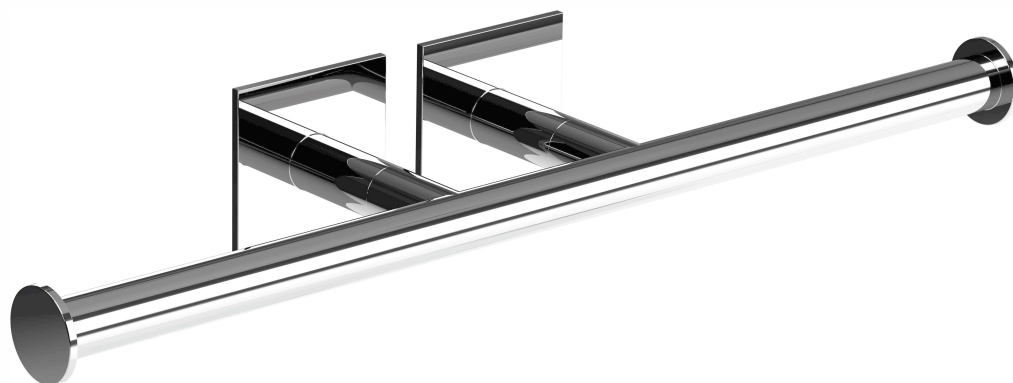

Features:

- Modern design combined with **PATENTED BridgeBind™** Manufacturing creates the ultimate in bath accessories
- Minimal, Elegant Design
- Hand Polished Stainless Steel

MECHANICAL DATA

Length: 13" (330mm)
Height: 2" (51mm)
Depth: 3" (76mm)
Tube Diameter: 0.625" (16mm)

COMPOSITION

18-8 (304) Stainless Steel

INSTALLATION

Includes Stainless Steel Screws to Install into **Adequate Structural Blocking**.
 Includes 3M® VHB Waterproof Tape.
 Can Be Installed with WINGITS® Fasteners when blocking is not available.

RECOMMENDED INTEGRATION

Install into **Adequate Structural Blocking** or with WINGITS® Fasteners.
 WINGITS® MODERN™ design is available in all Bath Accessories.

PATENTED

BridgeBind™ Technology



A steel dowel is expertly embedded in a stainless steel tube then arc welded to the tube's far side for the perfect structural synthesis

Front

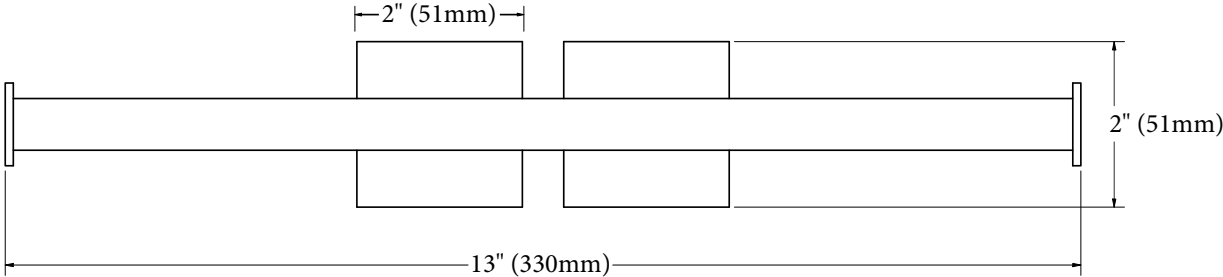



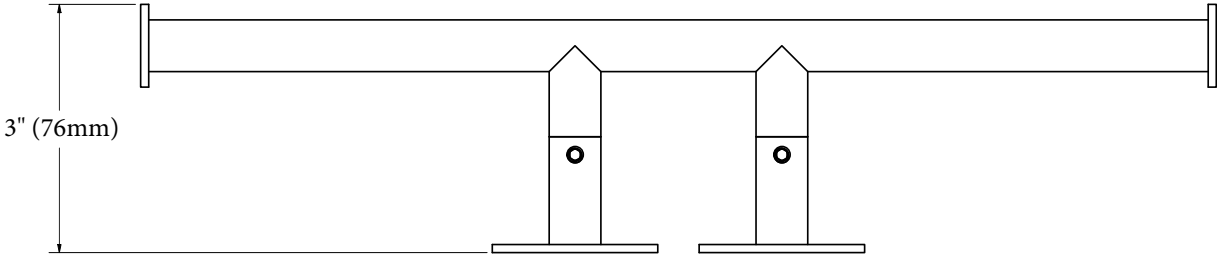

Bottom

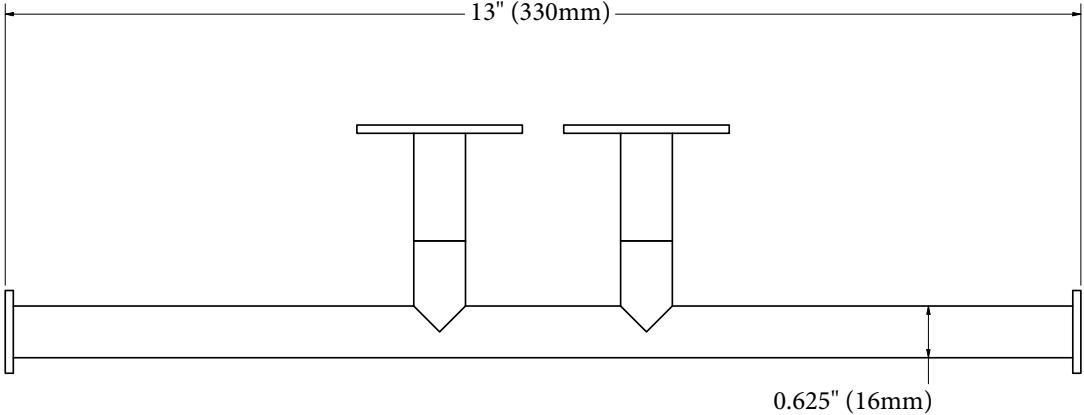

Top

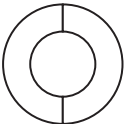

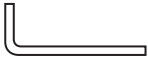
Included Hardware

-  3M[®] Waterproof Tape (2)
-  2.5" S/S Screw (2)
-  Allen Wrench (1)
-  Set Screw (2)

**Optional Hardware
(Sold Separately)**

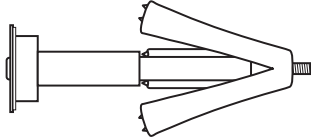
-  WINGITS[®] MASTER Anchor (MAW35)
(2)