

# WINGITS®

## MODERN Transitional™

### Toilet Paper Holder

Model:

# WMTTPH

Part Numbers:

WMTTPHPS  
Polished Finish

WMTTPHSN  
Satin Finish

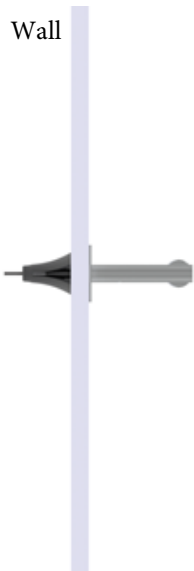

**Features:**

- Modern design combined with **PATENTED** BridgeBind™ Manufacturing creates the ultimate in bath accessories
- Unparalleled Strength
- Hand Polished Stainless Steel

<b>MECHANICAL DATA</b>
Length: 7.5" (191mm) Diameter: 2" (51mm) Depth: 3.625" (92mm)
<b>COMPOSITION</b>
18-8 (304) Stainless Steel
<b>INSTALLATION</b>
Includes Stainless Steel Screws to Install into <b>Adequate Structural Blocking</b> . Includes 3M® VHB Waterproof Tape. Can Be Installed with WINGITS® Fasteners when blocking is not available.
<b>RECOMMENDED INTEGRATION</b>
<b>PROPER INSTALLATION REQUIRES</b> use of 3M® VHB Waterproof Tape to stop rotation and <b>MUST</b> be installed into <b>Adequate Structural Blocking</b> or with optional WINGITS® Fasteners.  WINGITS® MODERN™ design is available in all Bath Accessories.

*PATENTED*  
**BridgeBind™ Technology**



A steel dowel is expertly embedded in a stainless steel tube then arc welded to the tube's far side for the perfect structural synthesis

**Front**

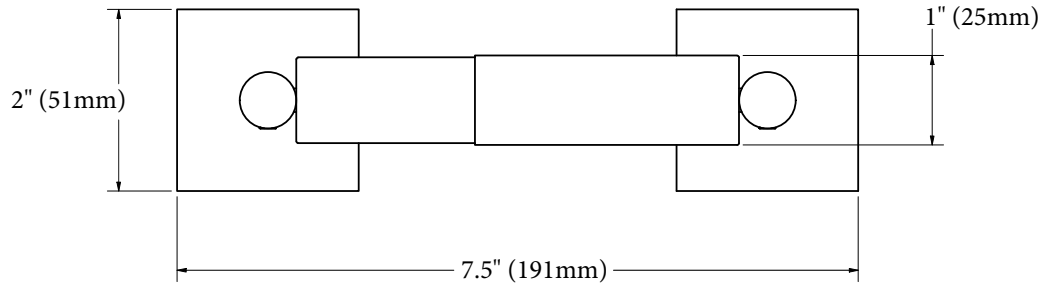

**Back**

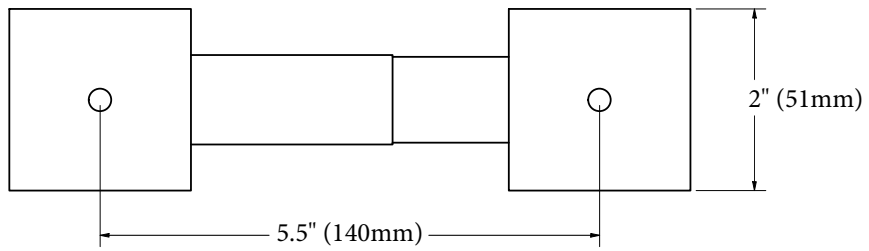

**Top**

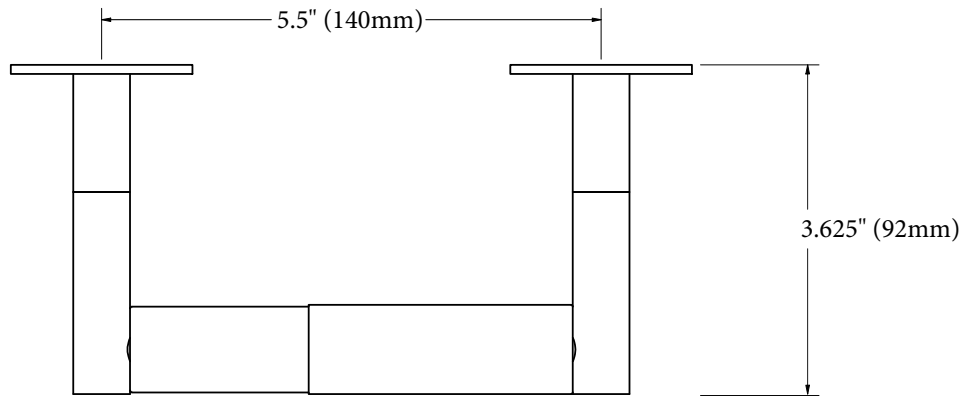

**Included Hardware**

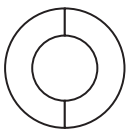

3M<sup>®</sup> Waterproof Tape (2)



2.5" S/S Screw (2)

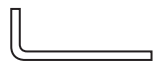

Allen Wrench (1)



Set Screw (2)

**Optional Hardware  
(Sold Separately)**

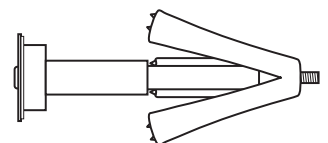

WINGITS<sup>®</sup> MASTER Anchor (MAW35)  
(2)